

CEN

Centrifugal Pumps



GENERAL

CEN series are industrial pumps of back pull out design according to JIS B8313.

APPLICATIONS

- General water supply, irrigation and drainage
- Pumping of sea water, brine, alkali and condensate
- Circulating hot and cold water supply
- Sprinkling & fire fighting system
- Swimming Pool

DESIGN

- End suction volute pumps with vertical centerline discharge
- Back Pull Out (BPO) design allows the removal all rotating elements without disturbing the casing, piping or motor

MATERIAL EXPLANATION

Bronze of BC2 or BC6 quality is recommended for sea water application or other corrosive media

IMPELLER

- Closed, radial flow impeller fitted with protective wear ring
- Balanced hydraulically
- Trimming of impeller is possible

BEARINGS

- Permanent lubricated grease ball bearings
- Oil lubricated bearing (*see option*)

SHAFT SEALS

- Strong stuffing boxes
- Single acting mechanical seal are available

FLANGES

- JIS 10 k F.F
- Optional with other flanges connection standard

DRIVE

Electric motors and engines are also available on request

DIRECTION OF ROTATION

Clockwise viewed from the drive end



PUMP SPECIFICATION

SPECIFICATION		STANDARD	OPTION *
CAPACITY		Up to 620 m ³ /h (170 l/s)	
TOTAL HEAD		Up to 100 m	
Product Temperature		-10°C to 100°C	-30°C - 120°C
Pump Discharge Pressure		Up to 10 bar	
Pump Size		32 mm to 150 mm	
MATERIAL	Volute Casing	Cast Iron FC250	Ductile FCD400 / Bronze BC6
	Casing Cover	Cast Iron FC250	Ductile FCD400 / Bronze BC6
	Bearing Housing	Cast Iron FC250	
	Impeller	Cast Iron FC200	Ductile FCD400 / Bronze BC6
	Shaft	Martensitic Steel SUS420J2	SUS316/SUS304
	Casing Wear Ring	Cast Iron FC200	Bronze BC6
	Impeller Wear Ring	Cast Iron FC200	Bronze BC6
	Shaft Protection Sleeve	Martensitic Steel SUS420J2	Austenitic Steel SUS304 / 316
Seal		Gland Packing	Mechanical Seal
Ball Bearing		Deep Groove	Open type
Lubrication		Grease	Oil

* all material combination within above mentioned material specification is possible

SECTIONAL DRAWING & LIST COMPONENT

PART NO.	PART DESIGNATION	MATERIAL	QTY
1020	Volute Casing	FC 250	1
1610	Casing Cover	FC 250	1
1830	Support Foot	SS 400	1
2100	Shaft	SUS 420J2	1
2300	Impeller	FC 200	1
3210.1	Ball Bearing	No. 63 - C3	1
3210.2	Ball Bearing	No. 63 - C3	1
3300	Bearing Housing	FC 250	1
3600.1	Bearing Cover	ADC 12	1
3600.2	Bearing Cover	ADC 12	1
4000.1	Flat Gasket	Valqua 6500	1
4000.2	Flat Gasket	Valqua 6500	1
4000.3	Flat Gasket	Valqua 6500	1
4230.1	Labyrinth Ring	Plastic	1
4230.2	Labyrinth Ring	Plastic	1
4520	Gland	FC 200	1
4540	Gland Bush	FC 200	1
4580	Lantern Ring	FC 200	1
4610	Gland Packing	Non Asbestos	3
5020	Casing Wearing	FC 200	1
5030	Impeller Wearing	FC 200	1
5240	Shaft Protecting Sleeve	SUS 420J2	1
5500	Washer Impeller*	SUS 304	1
9021	Gland Bolt	SUS 304	2
9201	Fine Hexagonal Nut	SS 400	1
9300	Spring Washer	SUS 304	1
9400.1	Key	S45C	1
9400.2	Key**	S45C	1

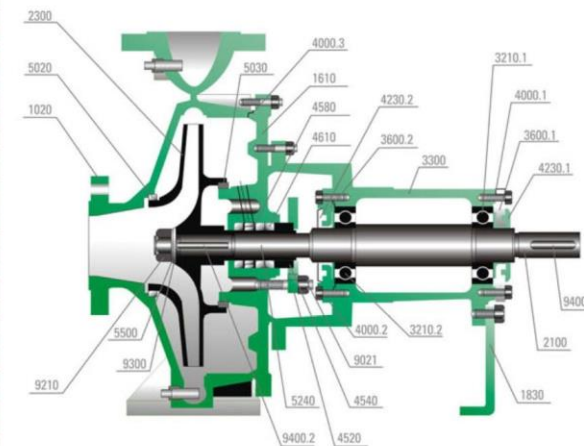

* Only use on Pump size with code (*)

** There are 2 size (each size 1 pc/unit pump) for Pump size with code (**)

50Hz-2P n=2900 1/min

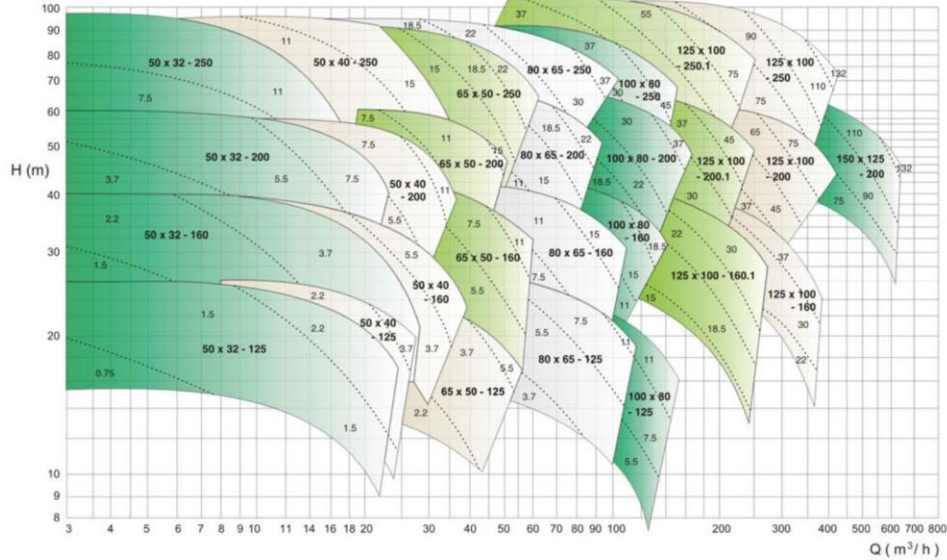

60Hz-2P n=3500 1/min

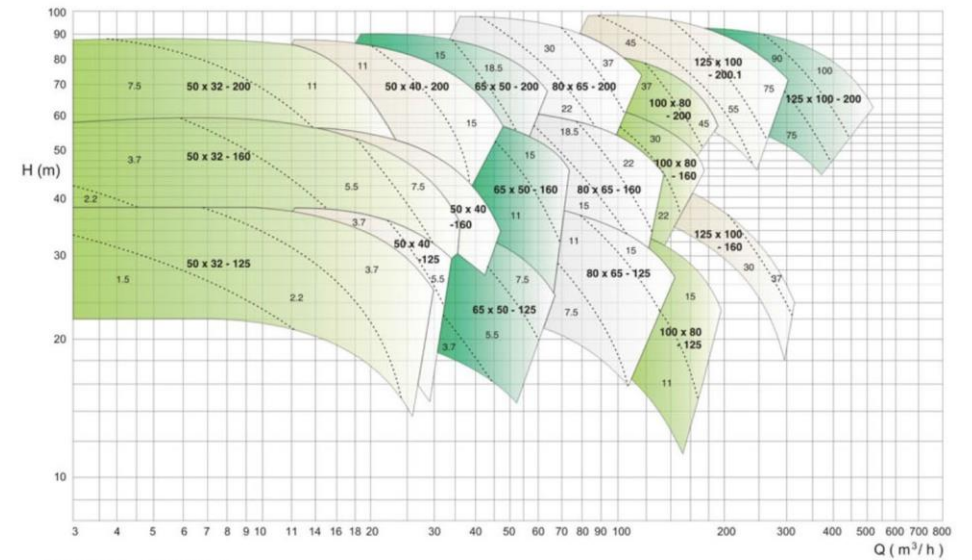

50Hz-4P n=1450 1/min

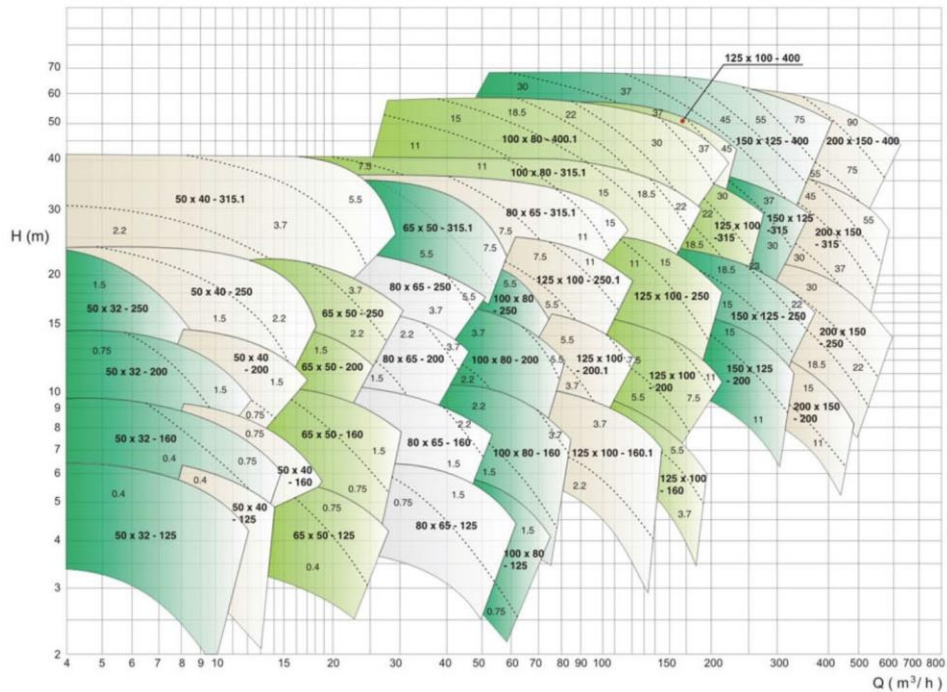

60Hz-4P n=1750 1/min

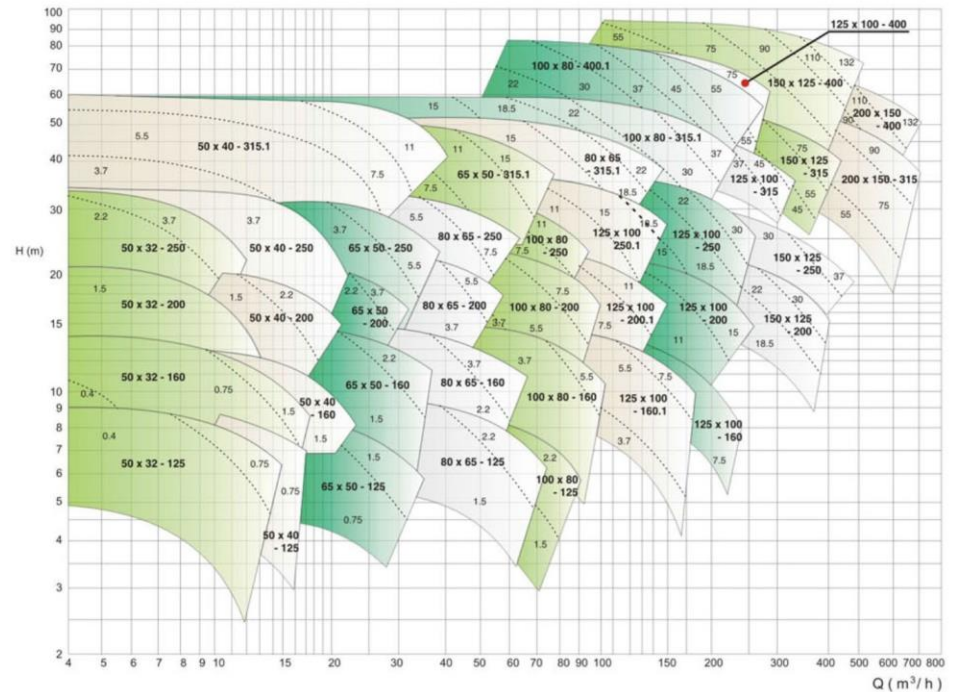

Notes

For types : 50 x 32 - 125, 50 x 32 - 250, 50 x 40 - 125, 50 x 40 - 160, 65 x 50 - 125, 80 x 65 - 125, 125 x 100 - 160.1 TGI does not produce.

Notes

For types : 50 x 32 - 125, 50 x 32 - 250, 50 x 40 - 125, 50 x 40 - 160, 65 x 50 - 125, 80 x 65 - 125, 125 x 100 - 160.1 TGI does not produce.

50Hz-2P n=2900 1/min

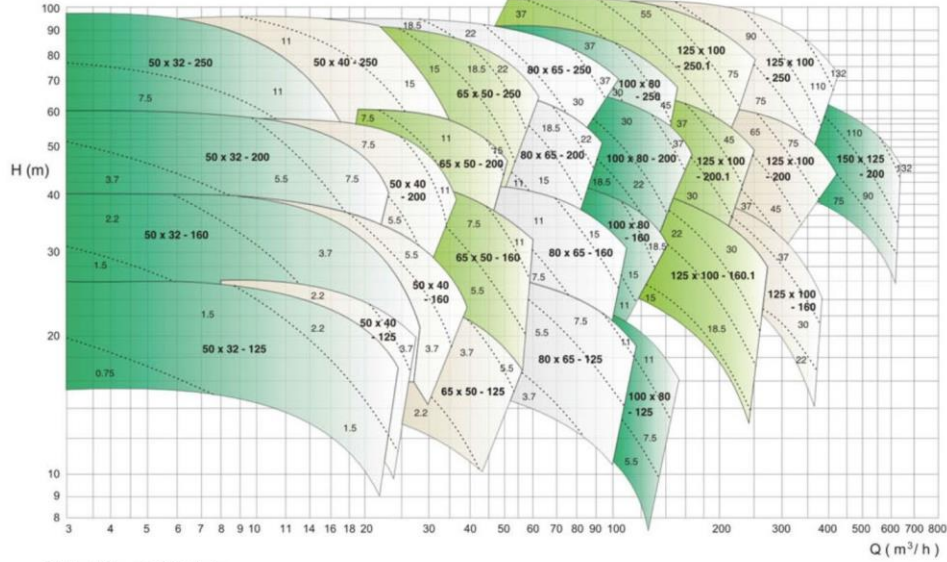

60Hz-2P n=3500 1/min

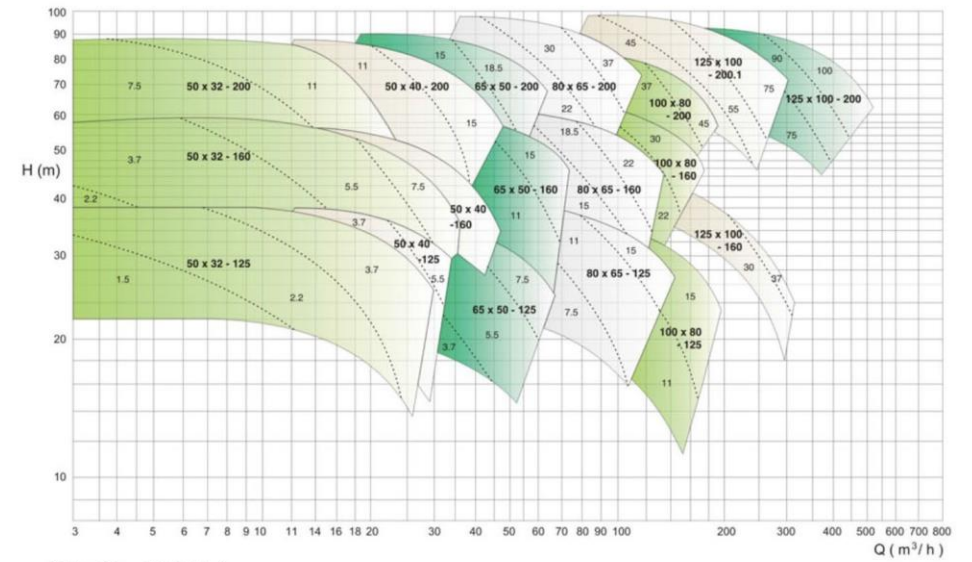

50Hz-4P n=1450 1/min

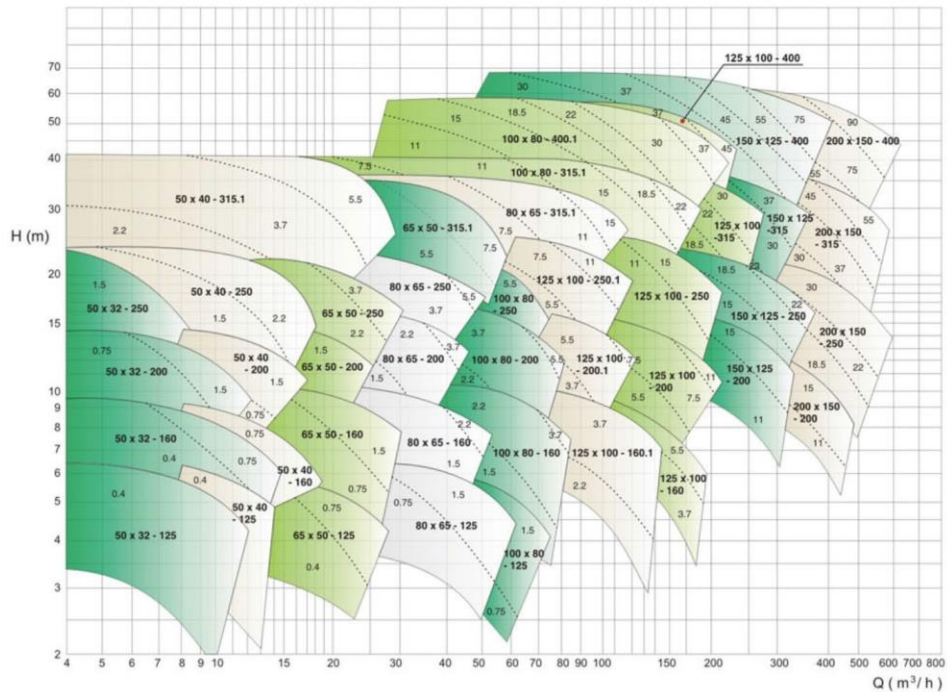

60Hz-4P n=1750 1/min

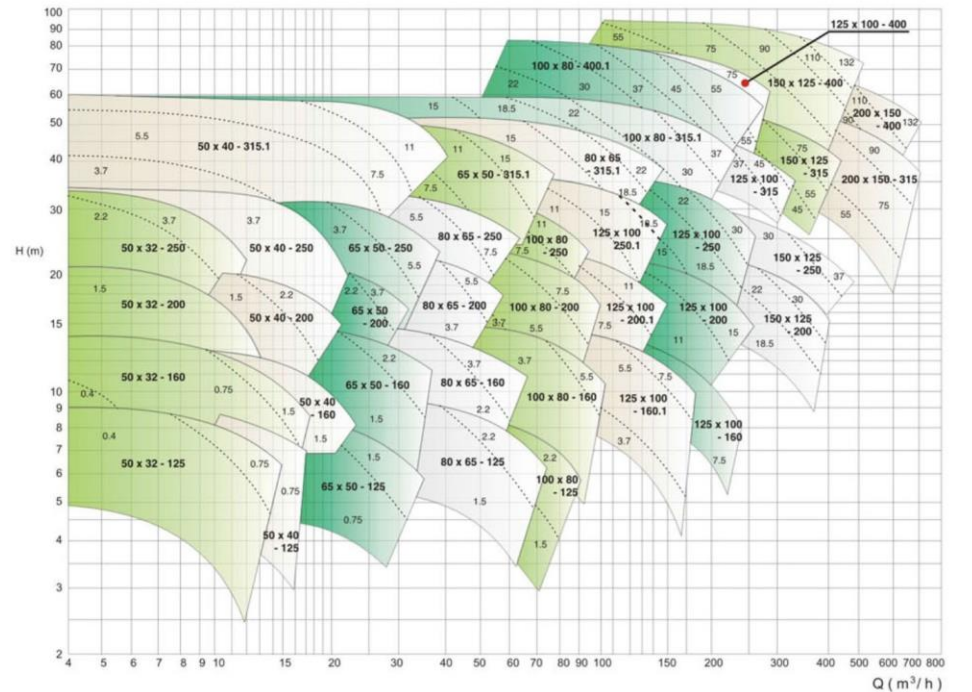

Notes

For types : 50 x 32 - 125, 50 x 32 - 250, 50 x 40 - 125, 50 x 40 - 160, 65 x 50 - 125, 80 x 65 - 125, 125 x 100 - 160.1 TGI does not produce.

Notes

For types : 50 x 32 - 125, 50 x 32 - 250, 50 x 40 - 125, 50 x 40 - 160, 65 x 50 - 125, 80 x 65 - 125, 125 x 100 - 160.1 TGI does not produce.